



F-Flash

Models: F1-18-120 & F1-18-240

OPERATION MANUAL & ASSEMBLY INSTRUCTIONS



• Operation, Assembly, and Parts List	Pg # 2-3
• Flash Troubleshooting	4
• F1-18 Wiring Diagram	5
• F1-18-240 Wiring Diagram	6
• Warranty/ Terms and Conditions	7-8

Vastex International, Inc.
 1032 N. Irving St.
 Allentown, Pa. 18109 USA
 Phone# 610 434-6004 Fax# 610 434-6607
 Web Site www.vastex.com

Vastex E-mail assistance

Purchasing & Product Info:
sales@vastex.com

Electrical Support:
stech@vastex.com

Tech Support, Mechanical Setup, and Operation:
techsupport@vastex.com

Screen Printing Issues & Support:
printech@vastex.com

Serial Number: VTX Date: / /

(Please log your machine's serial number and date of purchase for future reference.)

F-FLASH (F1-18) Operation Manual & Assembly Instructions

Component Identification

(1) Heater Head

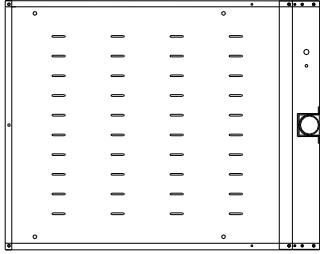

(4) Legs Part# 07-01-011

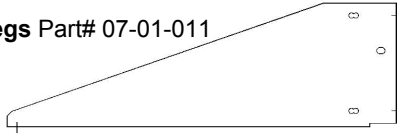

(1) Round Post Part# 07-04-007-0

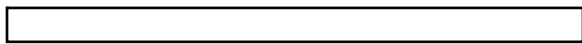

(1) Square Post Part# 07-04-008-0/07-04-009-0

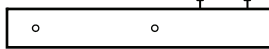

(1) Knob # 04-05-106



(1) Lock Collar # 04-05-004



(8) 1/4-20 x 1/2 Hex Head Bolts # 04-05-013



(1) 1/4-20 x 2 1/4 Hex Head Bolt # 04-05-289



(9) 1/4-20 Hex Nut # 04-05-008



(4) 3/8-16 Threaded Levelers # 04-06-027



(4) 3/8-16 Hex Nut # 04-05-285



(2) Handles Part# 07-03-011-0



(8) #8 x 3/8 Sht Metal Screws # 04-05-080



Overall Assembly Diagram

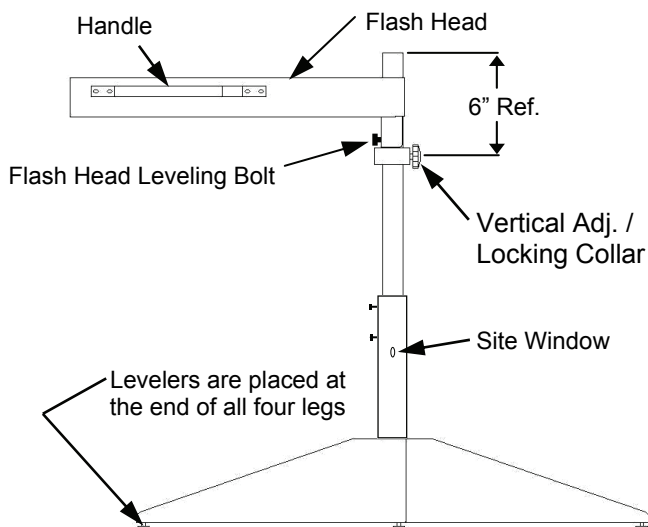

I Assembly

Inspect all packages while unpacking and notify the shipping company if any damages are detected. Your new spot heater head was assembled, tested (burned-in) and packaged in perfect condition in a proven container. Review drawings before starting assembly.

Tools needed: 1/4 wrench, (2) 7/16 wrenches or socket wrench, 9/16 wrench

- 1) To assemble the flash stand, position the (4) Legs, as shown below, and install the (8) 1/4-20 x 1/2 bolts and nuts. **DO NOT FULLY TIGHTEN HARDWARE YET, LEAVE LOOSE.**

1/4-20 x 1/2 bolt & nut. (8) req.

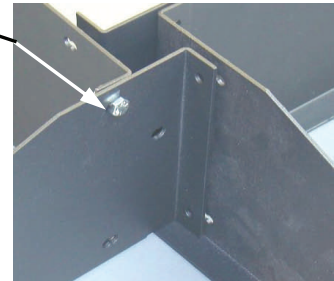

- 2) Slide the square post, with the center hole at the bottom and the (2) 5/16" bolts/floating nuts at the top, into the square hole created by the legs. (seen below) Insert the 1/4-20 x 2 1/4 lg. hex head bolt through legs and square post and fasten with 1/4" nut. Tighten with (2) 7/16 wrenches or socket wrench. Evenly tighten all hardware in the assembly. (Do not over tighten.)
- 3) Turn the assembly over and install four levelers or (optional) wheels, one at the end of each leg with (4) 3/8" nuts and washers. Tighten using 9/16" wrenches or socket wrench.
- 4) Install round post into square post. Slide the post down until you can see it through the Site Window. (Shown on left). Tighten the (2) 5/16-18 bolts to secure round post. **Do not over tighten bolts.**
- 4) Thread the knob into the lock collar and install the lock collar onto the post. Position the lock collar 6" (15 cm) down from the top of the post and tighten knob fully.

5/16" Bolts & floating nuts

Square Post

Legs

(Optional) Wheels

Round Post

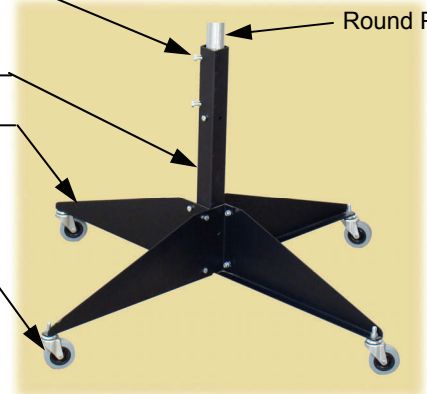

- 5) Unpack the heater head assembly and uncoil the line cord.

 **Be careful not to damage the heater surface!!!** 

- 6) Attach 2 handles, one to each side of the heater head with (8) #8 x 3/8 sheet metal screws using 1/4 wrench.
- 7) Carefully slide the heater head over the post to rest onto the lock collar.
- 8) While firmly supporting the heater head, loosen the locking knob and adjust the position of the heater to 2 to 4 inches (5 to 10 centimeters) above your shirt pallet.
- 9) Adjust the flash head parallel to the pallet. Use a 9/16 wrench to turn in or out the flash head leveling bolt.
- 10) **Make sure power switch is turned off.** Then plug the power cord into proper dedicated new outlet. (See Section II Electrical for requirements)
- 11) Flip the power switch to the on position, the pilot light will turn on and unit will be ready to use after warm up (approximately 15 minutes). (See Section IV Operation)

II Electrical

- 1) F-Flash will draw 15 amps at 120 volts. A heavy 12 gauge 15 amp 120V plug is supplied. The plug is configured like picture 5-15P.
- 2) **An electrician should be consulted for the installation of the outlet.**
- 3) F-Flash must have a minimum dedicated new 15 amp outlet (picture 5-15P) and 12 gauge wire feeding it. To minimize voltage loss, it is recommended that the F-Flash have a dedicated new 20 amp outlet (picture 5-20R), 12 gauge wire feeding it, and a 20 amp single pole breaker. (It is recommended that the F-Flash is the only thing plugged into the outlet and the whole line for optimal performance.)
- 4) F1-18-240 will draw 8 amps at 240 volts. A 15 amp 240V **plug** is supplied with the configuration shown below.



III Controls

1) Heat Controller

The control has positions L-2-3-4-5-6 and High. The controller turns the power to the heater on and off to vary the temperature. The higher the number on the controller the longer the on cycle and shorter the off cycle is. The High position keeps the power on constantly. Two pilot lights are provided, a power on and control output.

2) Power on

This RED light is wired to the controller. It will illuminate when the control is turned on, even if the controller has failed.

3) Control output light

The green pilot light is wired to the output side of the controller. When the controller is sending power to the heater, the pilot light will illuminate. This light will cycle on and off with the heater power.

IV Heating Operation

The F-FLASH will effectively dry all types of plastisols and thermoset inks. Set the control to position 5 and a distance of 2-4" from the face of the heater to the surface of the garment. The normal dwell time under the heater is the time you spend printing another garment. Nevertheless, 6-10 seconds is the time needed to effectively "skin-over" the ink deposit. Adjustments to the temperature control and distance may have to be made for the specific application. You should not try to final cure with a spot heater due to the fact that matching the precise time in heat of a conveyor will be difficult and can cause damage to your pallet. *(Caution should be taken when operating the flash unit. The heater surface is very hot. Never leave the flash unit on and left unattended.)*

Flash Troubleshooting

No heat from emitter

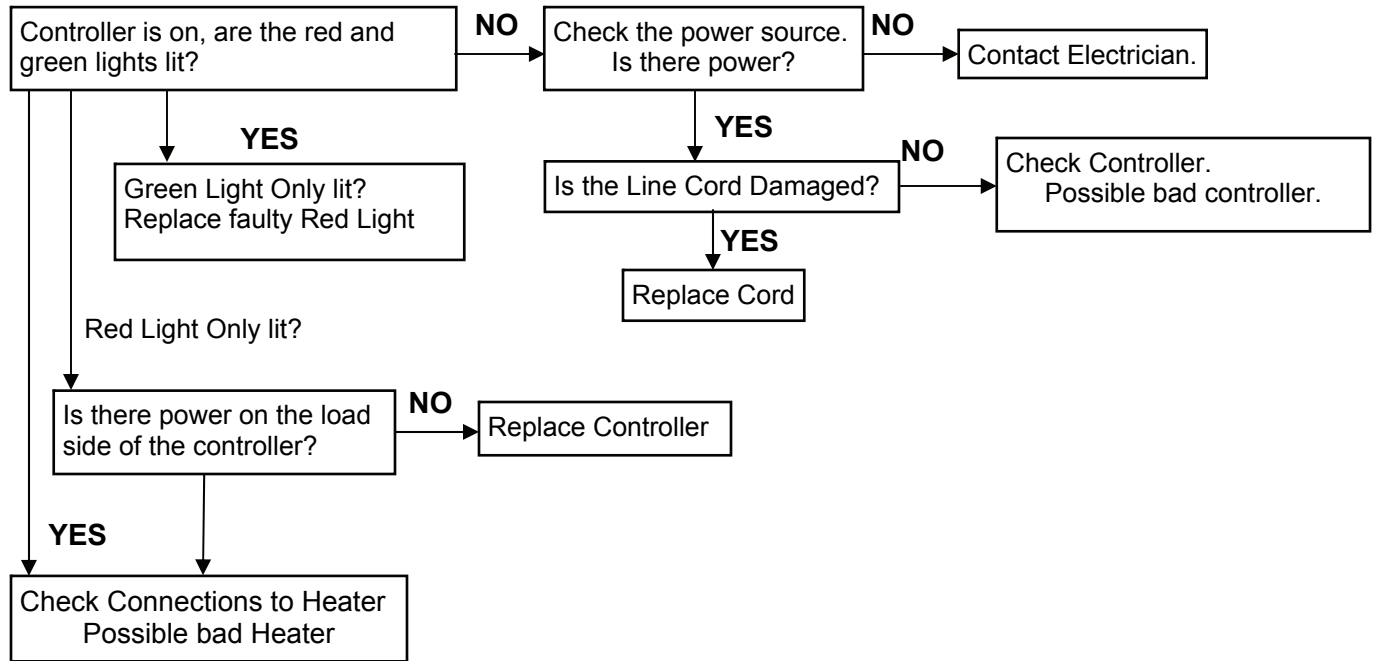

Vastex E-mail assistance

Purchasing & Product Info:

sales@vastex.com

Electrical Support:

stech@vastex.com

Tech Support, Mechanical Setup, and Operation

techsupport@vastex.com

Screen Printing Issues & Support:

printech@vastex.com

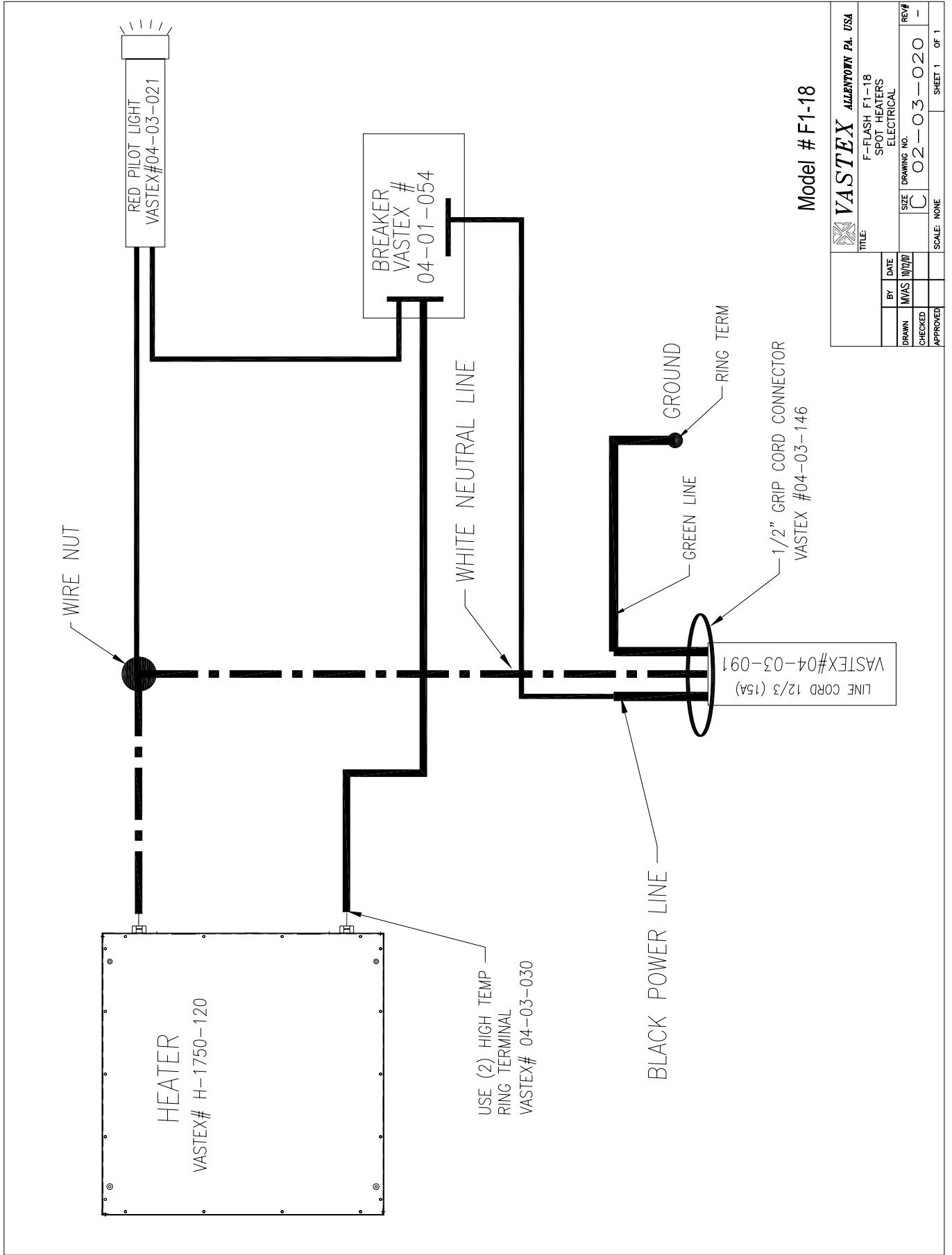

Model # F1-18

		TITLE: F-FLASH F1-18 SPOT HEATERS ELECTRICAL	
DRAWN MMS	BY MMS	DATE 11/20/00	SIZE C
CHECKED	APPROVED	DRAWING NO. 02-03-020	REV# -
SCALE: NONE			SHEET 1 OF 1

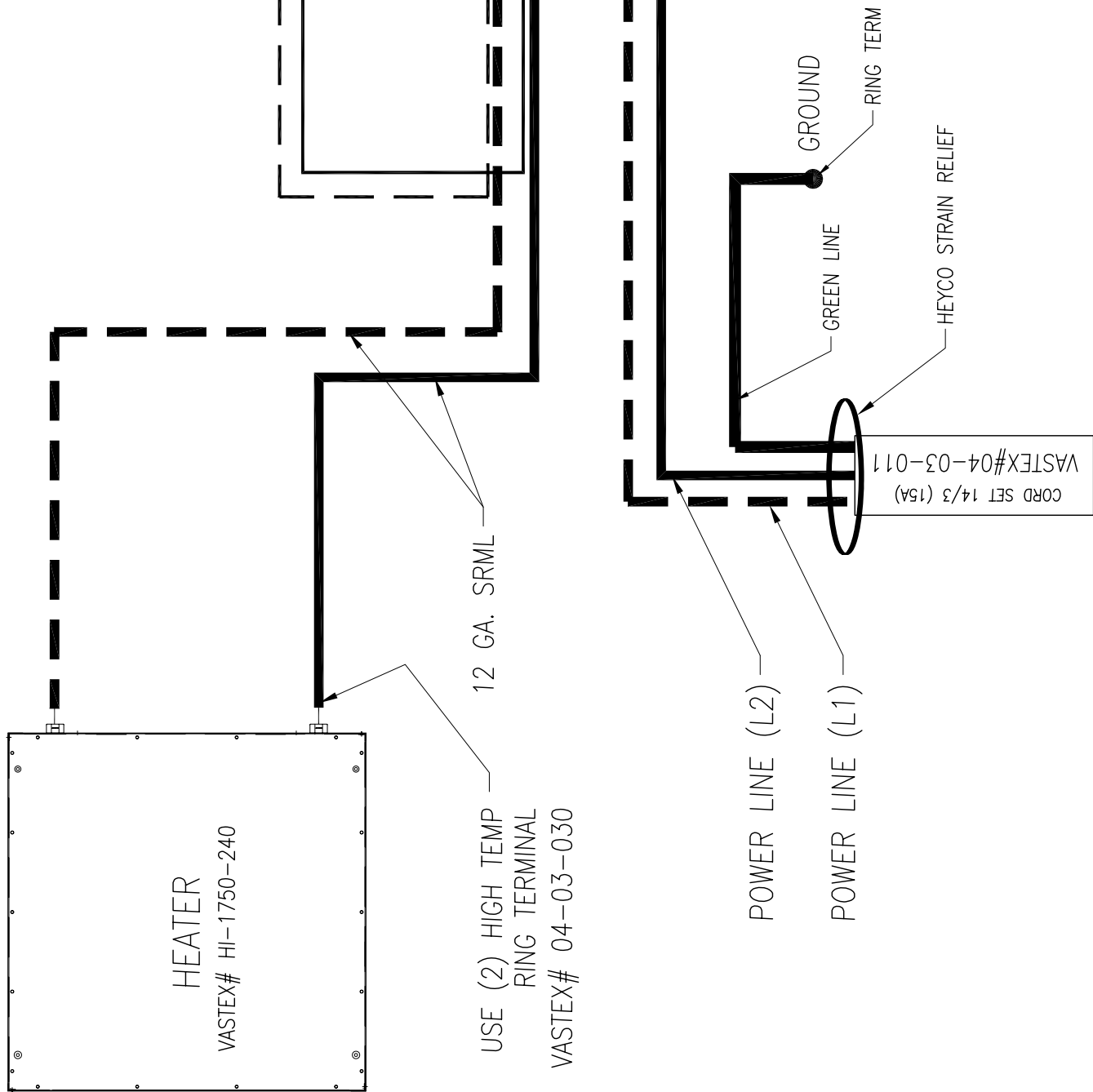

Model # F1-18-240

VASTEX ALLENTOWN PA. USA	
TITLE: F-FLASH F1-18-240 SPOT HEATERS ELECTRICAL	
DRAWN CD 07/15/08	SIZE C DRAWING NO. 02-03-022
CHECKED	REV# -
APPROVED	SCALE: NONE
SHEET 1 OF 1	

Vastex Warranty

Doc#01-00-005B Revised 10/15/07

(1.) Vastex, hereinafter referred to as “seller” warrants only to its original “purchaser”, who holds a copy of the original invoice and is the original end user of the equipment in question, its new equipment against defects in materials or workmanship on a pro-rated basis. Warranty period begins from date of shipment to the buyer and will only apply to customers paid in full. Warranty periods are as follows: one (1) year for E-1000, and V-1000, three (3) years for all other equipment (including F-Flash), ten (10) years for infrared heaters (excluding F-Flash) installed by Vastex in a new dryer, three (3) years for replacement infrared heaters, and one (1) year for replacement parts. Rubber blankets, light bulbs and glass on exposure units are particularly subject to wear while in use. Wear is not covered by this warranty but as stated above only manufacturers defects are covered. All sales made through Vastex dealers must be certified by that dealer before a warranty replacement is issued.

(2.) This warranty is expressly contingent upon the buyer delivering to seller, at the address below, with all transportation charges prepaid, the part or parts claimed to be defective within the above mentioned warranty periods stated in paragraph one. The defective part or parts will be repaired or replaced at the discretion of Vastex International, Inc. If the equipment in question is less than one (1) year old, it will be shipped to the customer at no charge, with an RGA issued by Vastex for the defective part. The defective part must be shipped back to Vastex freight prepaid within 30 days or the account will be billed. If the equipment is more than a year old, the part will be shipped after we receive the defective part. If it's necessary to expedite the movement of parts and to minimize down time to the buyer, the replacement part shall be supplied on a C.O.D. basis. If testing and analysis of said part by the seller or its supplier discloses that said part is defective, the cost of said part will be refunded to the buyer on a prorated basis.

(3.) Except as otherwise provided herein, the equipment is being sold “as-is”. Final determination of the suitability of the equipment for the use contemplated by the buyer, is the sole responsibility of buyer, and seller shall have no responsibility in connection with the suitability.

(4.) All warranties implied by law, including the implied warranties of merchantability and fitness are hereby limited to workmanship and defective parts to a warranty period stated in paragraph one. The express warranty and remedies contained herein and such implied limited warranties are made solely to the sole warranties and remedies and are in lieu of all other warranties, guarantees, agreements, and other liabilities, whether express or implied, and all other remedies for breach of warranty or any other liability of seller, in no event shall seller be liable for consequential damages.

No person, agent, distributor, or service representative is authorized to change, modify or extend the terms hereof in any manner whatsoever.

These terms and conditions are an essential part of the transaction between the parties and constitute the entire agreement between them with respect to the same.

Some states do not allow limitation on how long an implied warranty lasts of the exclusion or limitation of incidental, or consequential damages, so the above limitation may not apply to you.

This warranty gives you specific legal rights, and you may also have other rights which vary from state to state.

Infrared heaters are the only replacement parts covered for a period of (3) years from date of shipment and contingent to receipt of payment in full.

Electrical components can not be returned once installed unless proven defective.
Please refer to doc. 01-01-006 for warranty implementation help.
Please refer to doc. 01-00-015 for specific terms and conditions of sale and the limited warranty.
Please refer to doc. 01-00-017 for V-2000HD printer warranty.

F:\Shared\Vastex\01-Manuals & Doc\00-misc\01-00-005B_Warranty.doc

Vastex International, Inc.

VASTEX WARRANTY IMPLEMENTATION SHEET Doc.#01-00-006

Your new Vastex equipment is protected against *manufacturers' defects by our warranty, completely explained in doc# 01-00-017 for the V2000-HD series manual printer and in doc# 01-00-005 for all other Vastex manufactured equipment. Please refer to these documents for the **warranty term and specific concerns about the warranty. The following are some important facts and requirements for the proper implementation of the warranty.

- 1.0 Everything is covered!
2.0 **Warranty Term is defined as: Ship date from VASTEX to the date the item in question is returned to VASTEX for inspection and repair.
3.0 *Manufacturers defects are defined as: Parts determined to be defective in workmanship which will lead up to a premature failure. The determination will be made only by the manufacturer of the item in question.
4.0 To take advantage of the warranty the following steps must be taken:
4.1 The equipment must be paid for in full.
4.2 The item in question must be shipped to VASTEX for evaluation with all shipping costs incurred by the buyer.
4.3 If the item is deemed as a manufacturer's defect it will be repaired or replaced within 2 business days from the time received. The shipping cost back to the customer located in the continental United States will be paid by VASTEX if a warranty item.
4.4 If the item in question must be replaced immediately and is more than a year old, it will have to be purchased at list price and will be shipped COD. A pro-rated credit will be given promptly if the returned item is a valid manufacturer's defect.
4.5 If the equipment was shipped less than a year before the date of the service call and a technician confirms the part needed for repair, the replacement will be shipped before the replacement is shipped back. An RGA will be issued and must accompany the old part to VASTEX within 30 days or the account will be billed.
5.0 Important facts about the condition of shipped equipment:
5.1 Dryers are partially assembled with the belts tracked and the machine run at full temperature for a min. of 1 1/2 hours.
5.2 Printers are partially assembled, inspected, and adjusted for all heads down prior to partial disassembly and packing.
5.3 Exposing units are fully assembled and tested with the maximum screen size for vacuum integrity, timer operation and light output.
6.0 This document is in addition to the standard warranty and only helps the customer understand how to take advantage of the warranty. In no way does this document override the standard warranty or the terms and conditions of sale and the limited warranty doc# 01-00-015.
Please see doc# 01-00-015 for specific terms and conditions of sale and the limited warranty.

TERMS AND CONDITIONS OF SALE AND LIMITED WARRANTY Doc.#01-00-015

- 1. Buyer's order will constitute an offer in accordance with the terms hereof and such offer, upon acknowledgment of Seller, will constitute the agreement between Buyer and Seller. Buyer's order after such acknowledgment by Seller will not be subject to cancellation, change or reduction in amount, or suspension by Buyer of deliveries, unless prior to such action Buyer has obtained Seller's written consent. Notwithstanding anything to the contrary in Buyer's Purchase Order or other communications, the parties agree to be bound by these Terms and Conditions. Acceptance of the product by the Buyer shall be deemed to constitute unconditional acceptance of these Terms and Conditions.
2. Any of these terms, conditions and provisions of Buyer's order which are inconsistent with Seller's acknowledgment and these Terms and Conditions of Sale shall not be binding on the Seller and shall be considered not applicable to any sale so made. No waiver, alteration or modification of any of the provisions on either side of the document shall be binding upon Seller unless agreed to in writing by Seller.
3. (a) All prices are F.O.B. Seller's Plant and method of delivery and routing shall be at Seller's discretion, unless specifically otherwise stated herein. Notwithstanding any agreement to pay freight, delivery of products purchased hereunder to a common carrier or licensed trucker shall constitute delivery to Buyer and be determinative of the date and time of shipment and all risk of loss or damage in transit shall be borne by Buyer. If the Buyer fails to accept the goods from the common carrier or licensed trucker, the Seller shall be entitled to claim payment from the Buyer. Seller shall arrange for storage, the risk and the cost, including insurance costs, to be borne by the Buyer (and Buyer agrees to pay such amounts upon demand) except if the failure to accept delivery is due to any of the exceptions noted in Paragraph 4.
(b) Terms of payment shall be as stated on invoice.
4. It is understood that deliveries will be made in accordance with Seller's regular production schedule. Every reasonable effort will be made to meet the Buyer's required delivery dates but Seller will not be liable for damages or be deemed to be in default by reason of any failure to deliver or delay in delivery due to any preference, priority, allocation or allotment order issued by the Government, whether Federal, State or local, or causes beyond its control including but not limited to, Acts of God or a public enemy, acts of Government, fires, floods, epidemics, quarantine restrictions, strikes, lockouts, freight embargoes, severe weather, unavailability of materials or shipping space, delays of carriers or suppliers or delays of any subcontractors. Should delay in delivery be caused by any of the circumstances mentioned in this paragraph, such extension of the delivery period shall be granted as is reasonable under the circumstances of the case. Should delay be caused by an event not specifically mentioned in this paragraph, damages will be limited to cancellation of the purchase order without penalty, and refund of any monies deposited or prepaid on the purchase order with no liability for any consequential or incidental damages.
5. Seller reserves the right to increase the prices prior to Seller's acceptance of order and/or after expiration of any price quoted by Seller.
6. Unless otherwise stated in writing, Seller's prices do not include sales, excise, value-added or other taxes. Consequently, in addition to the price specified herein, the amount of any present or future sales, use, excise, value-added or other tax applicable to the manufacture, sale, purchase or use of the products hereunder shall be paid by Buyer, or in lieu thereof, Buyer shall provide Seller with a valid tax exemption certificate acceptable to the taxing authorities.
7. Seller reserves the right, at any time, to revoke any credit extended to Buyer because of Buyer's failure to pay for any products when due or for any other reason deemed good and sufficient by Seller and in such event, all subsequent shipments shall be paid for prior to at delivery at Seller's option.
8. (a) SELLER'S LIABILITY SHALL BE LIMITED TO SELLER'S STATED SELLING PRICE PER UNIT OF ANY DEFECTIVE GOODS AND SHALL IN NO EVENT INCLUDE BUYER'S MANUFACTURING COSTS, LOST PROFITS, GOODWILL, OR ANY OTHER SPECIAL, INDIRECT, INCIDENTAL OR CONSEQUENTIAL DAMAGES, ARISING OUT OF THE AGREEMENT, THIS CONTRACT, THE SALE OF THE PRODUCTS TO THE BUYER OR THE USE OR THE PERFORMANCE OF THE PRODUCTS. Seller may at its discretion repair, replace or give the Buyer credit (pro-rated) for such defective products.
(b) Notwithstanding anything herein to the contrary, Seller shall have no liability for alleged defects with the products which are not specified in written notice from the Buyer to the Seller within thirty-six (36) months from the date of shipment of machines. Seller shall pass to Buyer any warranty received by Seller from the manufacturer of Limited Life Components, which in most cases is 12 to 18 months.
(c) Seller shall have no liability under this Limited Warranty unless Buyer has paid in full for the products. Further, this Limited Warranty is expressly contingent on Buyer's delivery to Seller, all costs prepaid, the defective part(s) within thirty-six (36) months of shipment to Buyer, together with a written statement specifying the alleged defect(s). Any replacement part(s) shall be shipped to Buyer on a C.O.D. basis.
(d) SELLER SPECIFICALLY EXCLUDES ALL WARRANTIES, EXPRESSED, IMPLIED OR OTHERWISE, EXCEPT AS STATED EXPLICITLY IN THESE TERMS AND CONDITIONS OF SALE. SELLER DISCLAIMS THE WARRANTY OF MERCHANTABILITY AND FITNESS FOR A PARTICULAR PURPOSE.
9. The remedies herein reserved by Seller shall be cumulative and in addition to any other legal remedies. No waiver of a breach of any portion of this contract shall constitute a waiver of continuing or future breach of such provision or of any other provisions hereof.
10. These Terms and Conditions constitute the entire agreement of the parties. No amendments, changes, revisions or discharges hereof in whole or in part shall have any force or effect unless set forth in writing and signed by the parties hereto. This contract shall not be assignable by Buyer voluntarily by operation of law or otherwise without Seller's written consent.
11. This contract shall be governed and shall be construed according to the domestic laws of the Commonwealth of Pennsylvania.
12. Anything herein to the contrary notwithstanding, any action for alleged breach by Seller of the contract between the parties, including but not limited to any action for breach of the warranties herein set forth, shall be barred unless commenced by Buyer within one (1) year from the date such cause of action accrued.
13. This agreement shall inure to the benefit of and be binding upon the parties hereto, their respective successors and permitted assigns.
14. All notices required by this contract to be given by either party shall be sent in writing or by facsimile and shall be addressed to the last known address of such other party. Notices shall be deemed to have been received on the fifth business day following deposit in the mail.